

AHCC SERIES- CASED HYDRONIC HEATING

Model: AHCC-3-195

The AHCC Series Cased Hydronic Heating Units are designed to provide exceptional hydronic heating when matched with any residential air handling system and a hot water source. The unit may be mounted upflow, counter flow or horizontally on the supply end of the air handler or within the duct system. The coils are designed and tested in accordance with the current AHRI Standard 410 and manufactured with UL listed components.

- High Performance Aluminum Fins
- Galvanized Casing with Access Panel
- Simple Installation in Multiple Configurations

Available through our large network of wholesale distributors.

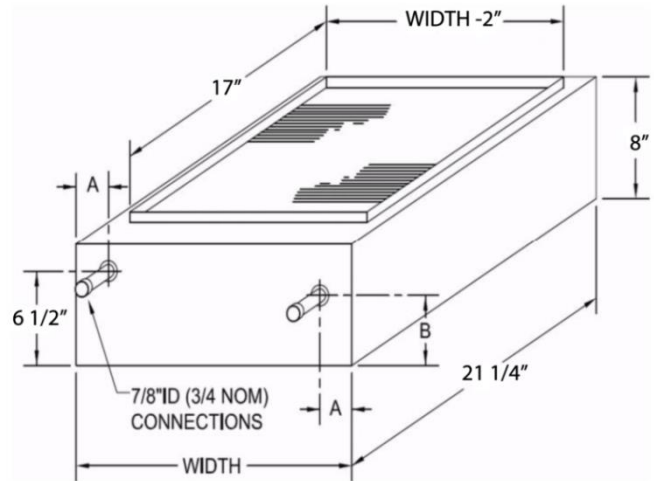

3 Row Unit			
Model	Width	A	B
AHCC-3-195	19-1/2"	2"	4-11/32"

Model Number: AHCC-3-210									
Total CFM	Ent. Dry Bulb °F	Lvg. Dry Bulb °F	Total Capacity MBH	Air Press. Drop "WG	Fluid Type	Total Flow Rate GPM	Ent. Fluid Temp. °F	Lvg. Fluid Temp °F	Fld Press. Drop 'WG
600	65.0	132.02	45.3	0.11	Water	5.8	160	144.52	4.99
700	65.0	129.87	51.2	0.14	Water	6.5	160	144.41	6.12
800	65.0	127.74	56.6	0.18	Water	7.0	160	143.99	6.99
900	65.0	125.95	61.9	0.22	Water	7.6	160	143.89	8.11
1000	65.0	124.24	66.9	0.26	Water	8.1	160	143.67	8.49
1100	65.0	122.69	71.6	0.28	Water	8.6	160	143.53	9.48
1200	65.0	121.18	76.0	0.33	Water	9.0	160	143.28	10.31
600	65.0	146.36	55.1	0.11	Water	5.8	180	161.12	4.89
700	65.0	143.76	62.2	0.14	Water	6.5	180	160.98	6.00
800	65.0	141.19	68.8	0.18	Water	7.0	180	160.47	6.85
900	65.0	139.03	75.2	0.22	Water	7.6	180	160.34	7.95
1000	65.0	136.96	81.2	0.26	Water	8.1	180	160.08	8.32
1100	65.0	135.08	86.8	0.28	Water	8.6	180	159.90	9.28
1200	65.0	133.26	92.4	0.33	Water	9.0	180	159.59	10.09